

2023

Product Guide

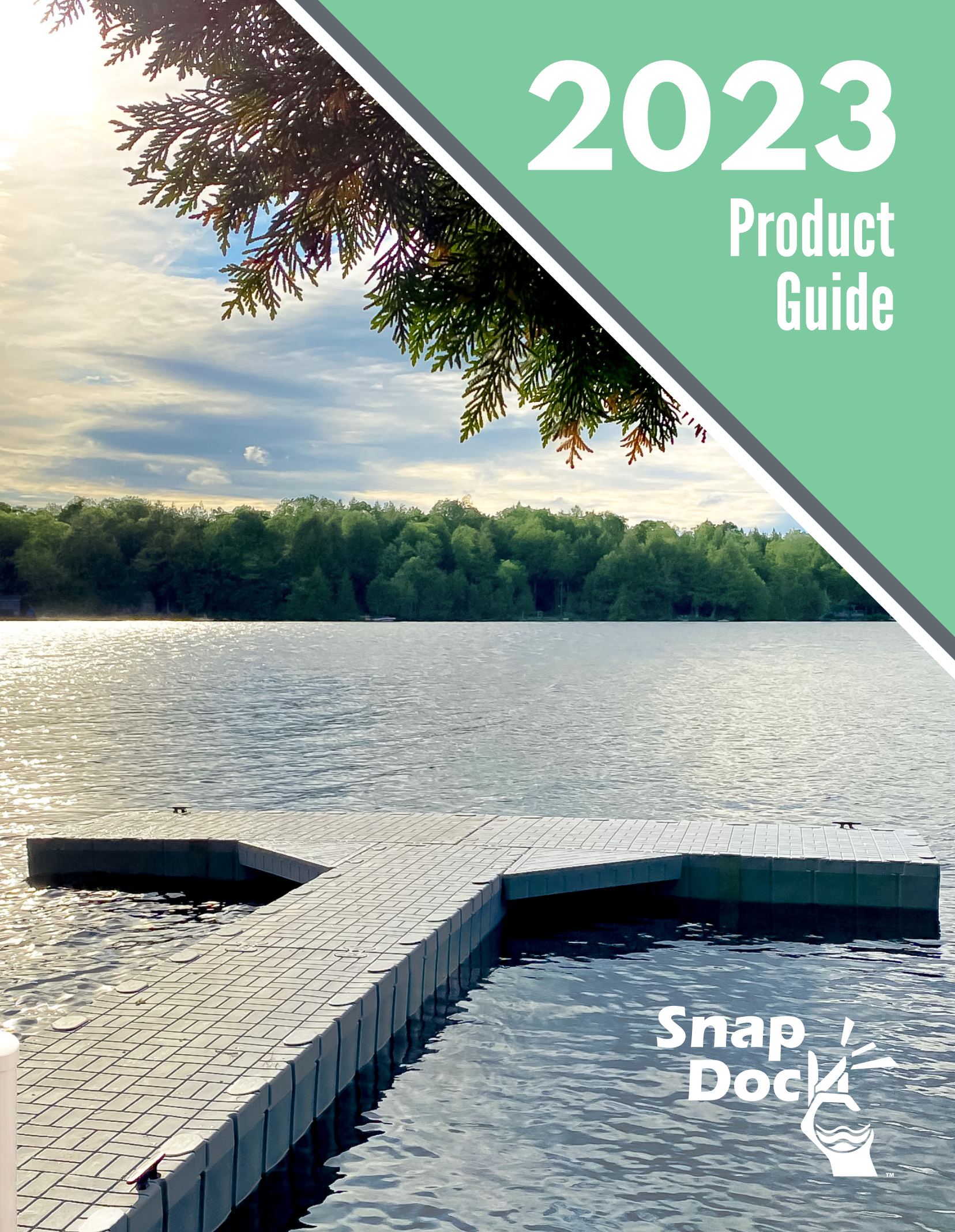

C Contents



6

New 2023 Products

4060 Dock Section 80" Dock Section Piling Bracket
Bumper

7

Product Specifications

40" Dock Section 4060 Dock Section 60" Dock Section
80" Dock Section Snap Port

8

Dock Section Dimensions

40" Dock Section 4060 Dock Section 60" Dock Section
80" Dock Section Snap Port

13

Snap Port Installation Options

Specifications Attachment Options

14

Snap Port Accessories

Port Roller Long Set Port Roller Short Set
Port Cover Kit Port Coupler Set Pocket Fillers

15

Modular Gangways & Ramps

Accessories



17

Coupler System

18

Half Coupler Hardware Connectors

Center-To-Center Distance Between Pockets
Cleat Mounting Location

19

Anchoring

Hinge Kits Pipe Brackets Piling Bracket
Stand Off Bracket Deadweight Brackets Stiff Arm Bracket

25

Snap Dock Builder

Tutorial

27

Residential Configurations

" T " Floating Dock Platform Floating Dock
Multi Port & 60" Dock Configuration
Multi Port & 40" Dock Configuration

28

Commercial Configurations

" U " Shape Multi-Slip Dock Platform Floating Dock
Multi-Slip Snap Port Dock Multi-Slip Marina

29

Industrial Configurations

Work Platform Walkway

30

Product Catalog





Our Story

Snap Dock's story began in 1982 when our parent company first patented a rotationally molded collapsible container, quickly becoming the standard for the automotive and manufacturing industries. The company later expanded into other rotational molded products that serve the industrial market. Along the way, we saw an unmet need for an industrial floating walkway system that could be rapidly deployed. In 2018, Snap Dock rolled out a polyethylene floating walkway into the industrial market. After finding success with that product, we began developing a recreational lineup according to the same core tenets of durability and ease-of-use, launched in 2021.

We look forward to continuing to expand our product selection of best-in-class floating docks and accessories.



The Snap Dock Advantage

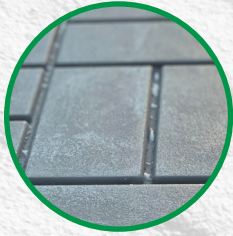

Attractive Non-Slip Surface

All dock sections feature an attractive non-slip surface that channels water and helps conceal dirt.

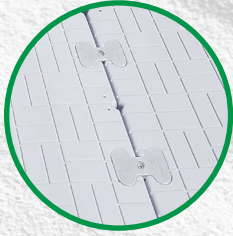

Seamless Color Integration

Snap Dock's coupler system matches the color of dock components.



Reinforced Surface Support

Snap Dock components are engineered to reduce deflection on the walking surface.



Unmatched Strength

Snap Dock's coupler system allows our docks to withstand significant wave action in rough water.



Industrial Grade Durability

All Snap Dock modular components are rotationally molded with industrial grade plastic (LLDPE) ensuring consistent performance in the most extreme weather conditions.



Customer Experience

We are committed to creating a family-like customer experience for distributors, dealers, and end-users.



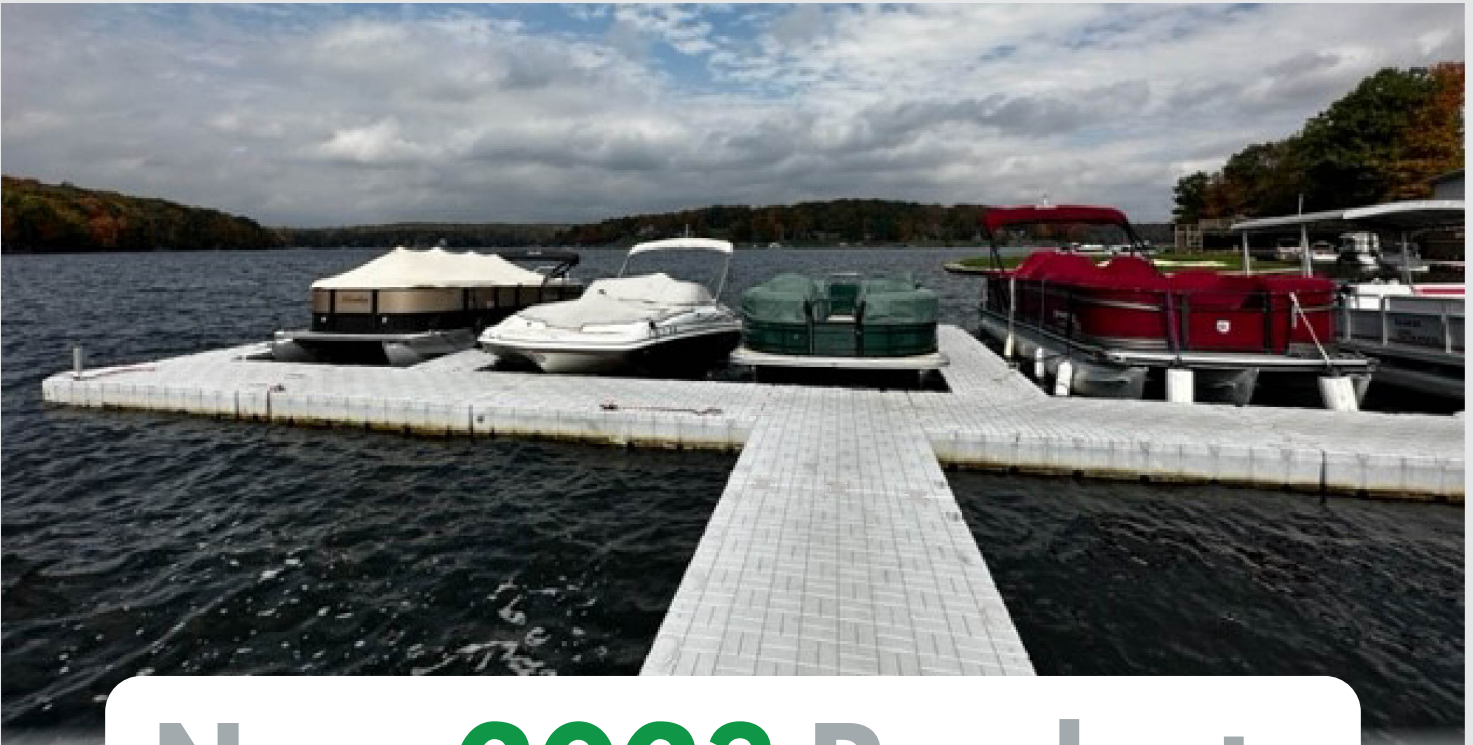

New 2023 Products

New



4060 Dock Section

This section is perfect for adding on additional dock square footage to a new or existing configuration, filling in unused space.

Refer to [page 7](#) product for more details.

New

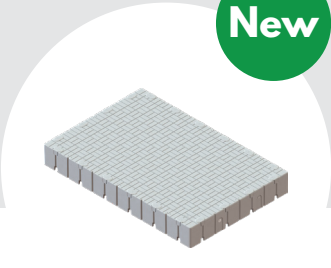

80" Dock Section

Our largest dock section yet! Great for residential and commercial applications.

Refer to [page 7](#) product for more details.

New



Piling Bracket

Our Piling Bracket fits up to a sixteen inch piling with a removable wear ring that won't damage the piling.

Refer to [page 21](#) product for more details.

New



Bumper

Protect your dock and boat with our new Bumper. Designed with a molded-in top coupler for easy installation.

Refer to [page 43](#) product for more details.



Product Specifications

40" Dock Section

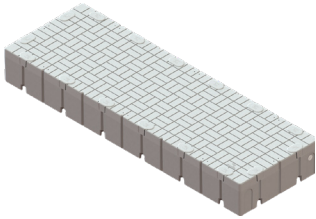

Buoyancy	2150 lbs./ 975 kgs.
Weight	178 lbs/ 81 kgs.
Dimensions	117" x 39"
SKU	SNAP120x40-GR

4060 Dock Section

Buoyancy	997 lbs./ 453 kgs.
Weight	119 lbs/ 54 kgs.
Dimensions	59" x 39"
SKU	SNAP60x40-GR

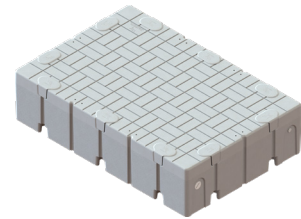

60" Dock Section

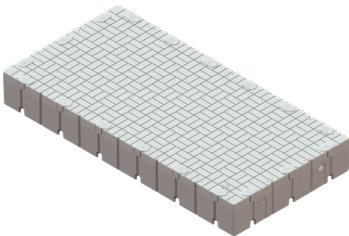

Buoyancy	3150 lbs./ 1440 kgs.
Weight	270 lbs/ 122 kgs.
Dimensions	117" x 59"
SKU	SNAP120x60-GR 2020

80" Dock Section

Buoyancy	4224 lbs./ 1916 kgs.
Weight	330 lbs/ 150 kgs.
Dimensions	117" x 79"
SKU	SNAP120x80-GR

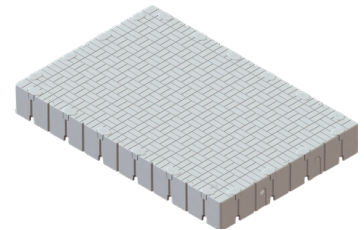

Snap Port

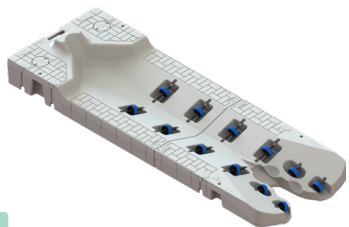

Buoyancy	1750 lbs./ 794 kgs.
Weight	370 lbs/ 168 kgs.
Dimensions	168" x 59"
SKU	SNAP PORT-ASSY-GR



40" Dock Dimensions

Top View Geometry

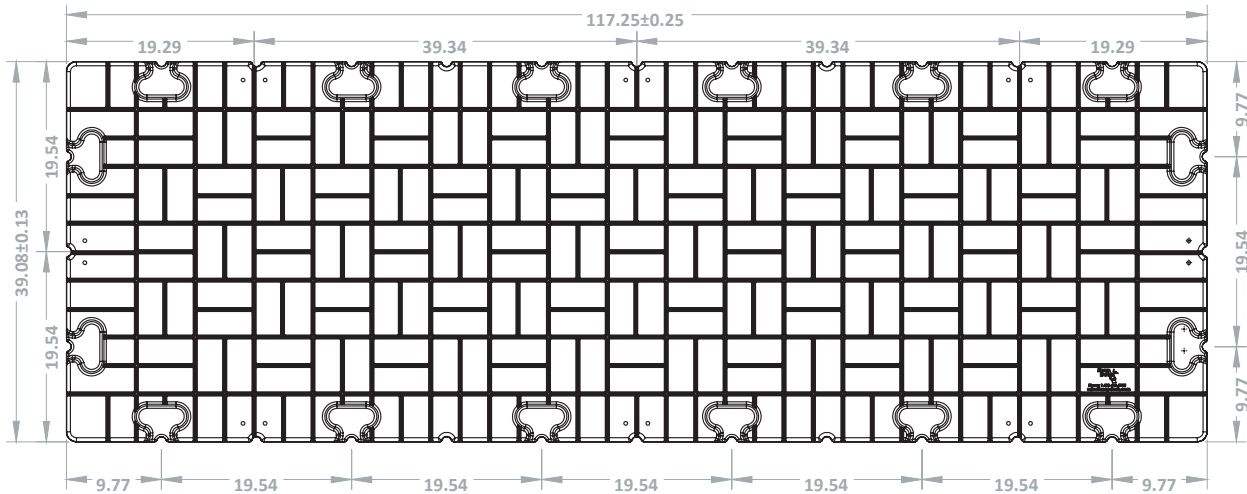

End View Geometry

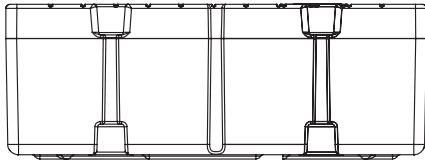

Side View Geometry

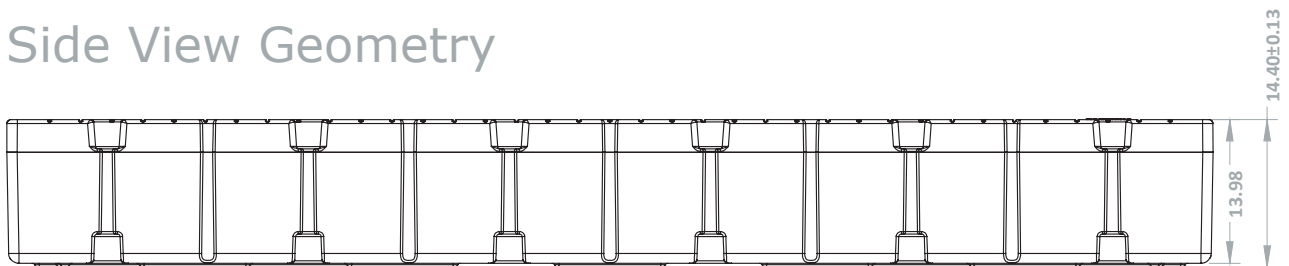

4060 Dock Dimensions

Top View Geometry

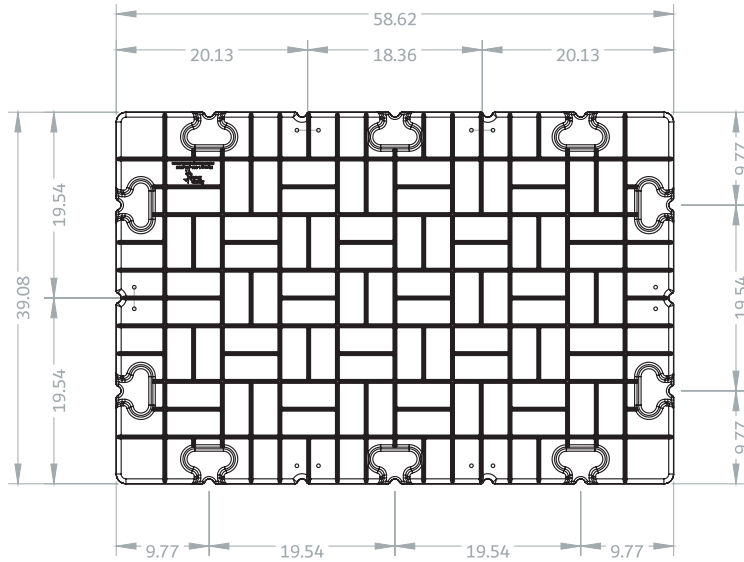

End View Geometry

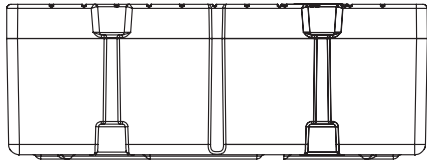

Side View Geometry

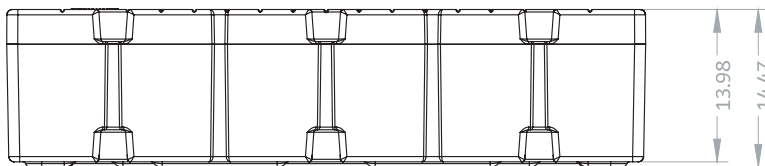

60" Dock Dimensions

Top View Geometry

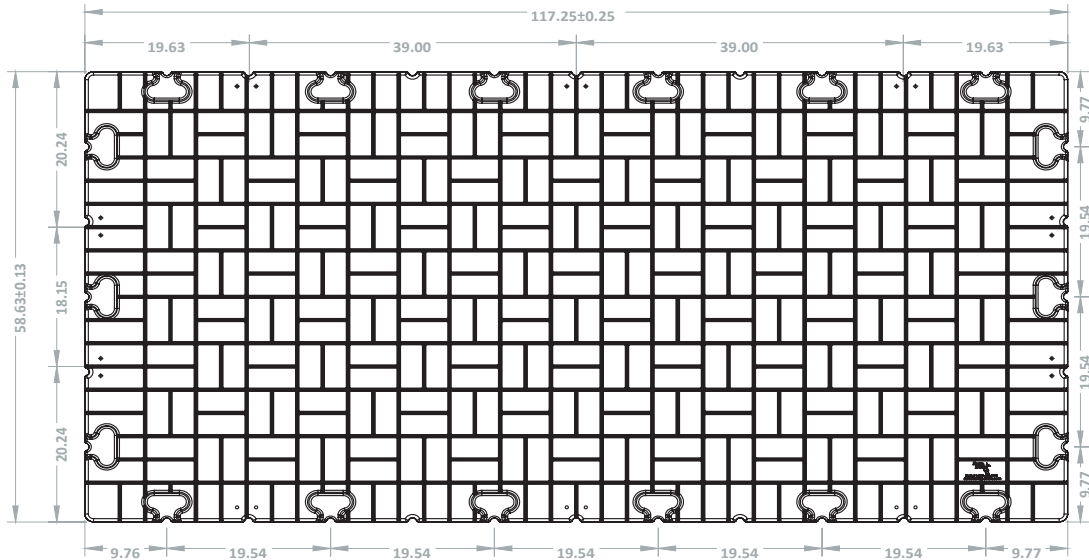

End View Geometry

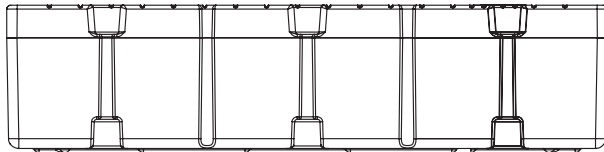

Side View Geometry

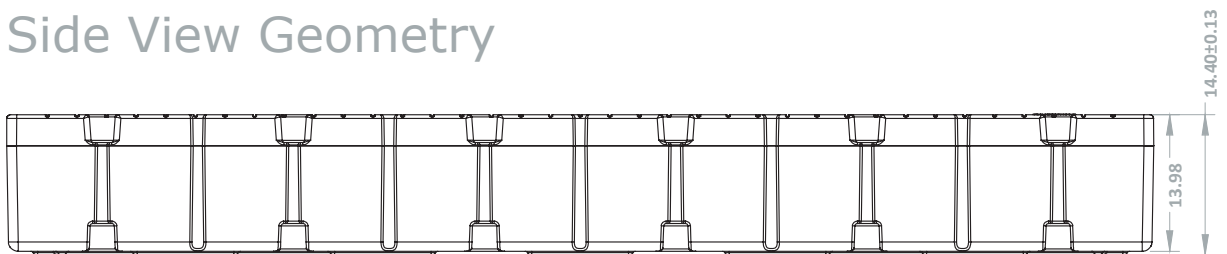

80" Dock Dimensions

Top View Geometry

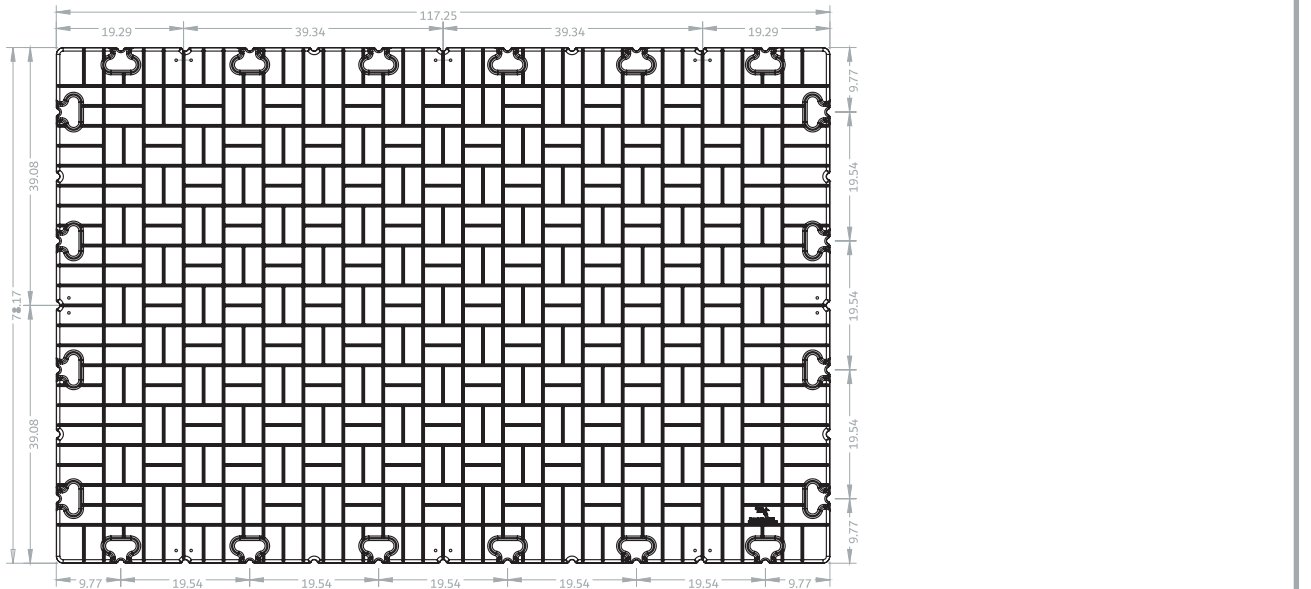

End View Geometry

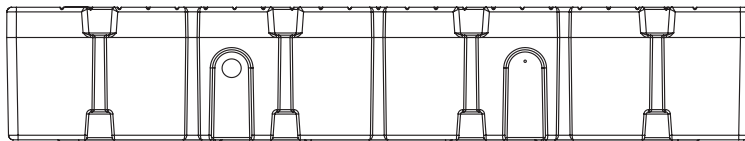

Side View Geometry

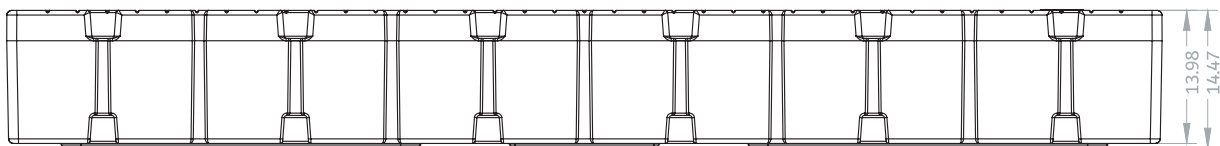

Snap Port Dimensions

Top View Geometry

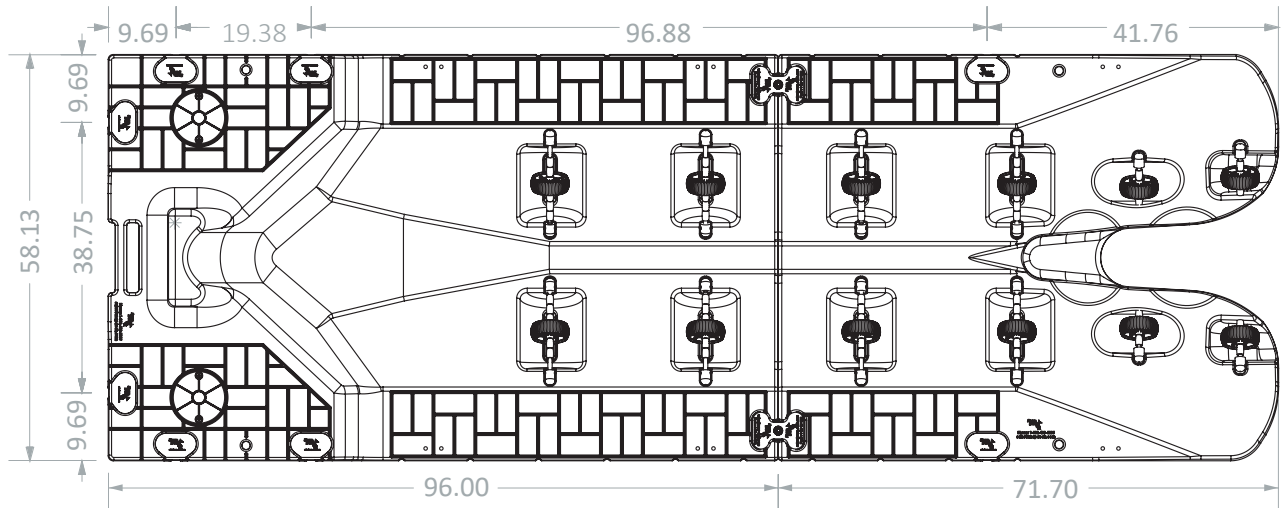

End View Geometry

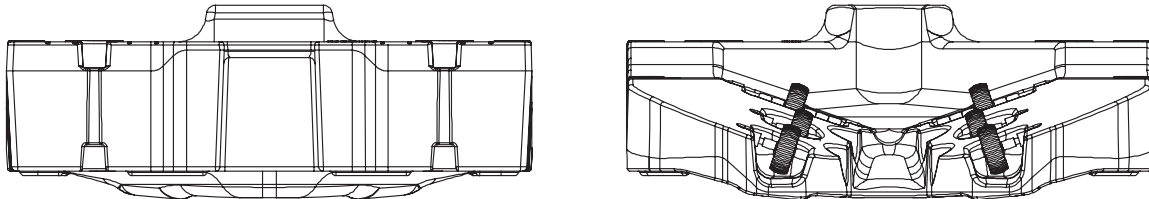

Side View Geometry

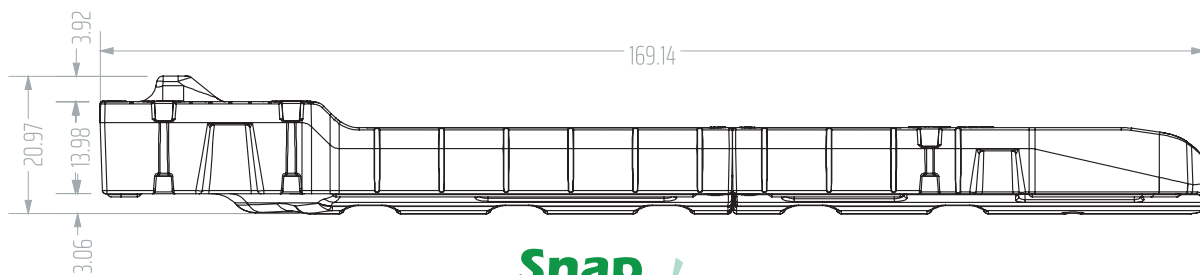

Snap Port Installation Options

Poly Bracket

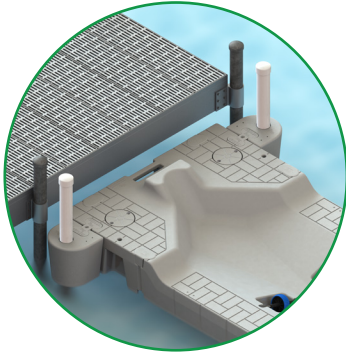

Hinge Adapter Kit

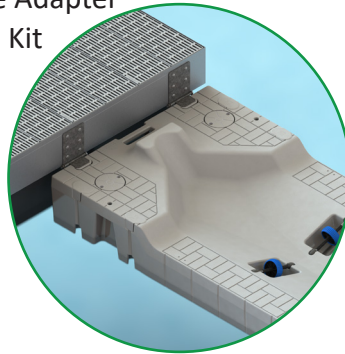

Coupler Set Attachment

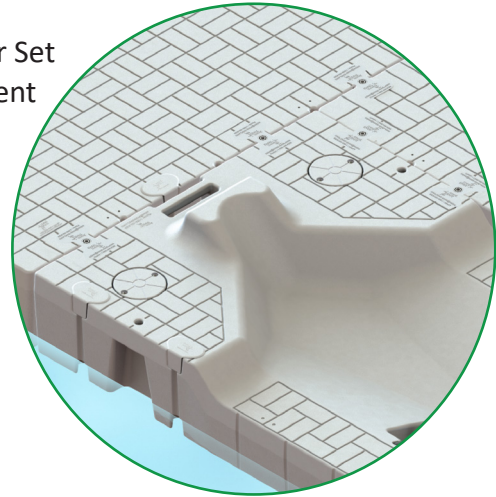

Stand off Bracket

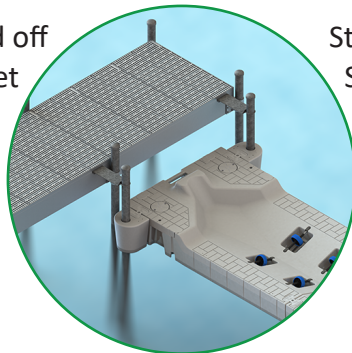

Stand Alone Snap Port

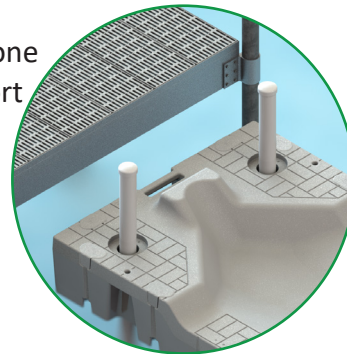

Specifications

Buoyancy	1750 lbs./ 794 kgs.
Weight	370 lbs/ 168 kgs.
Dimensions	168" x 59"
SKU	SNAP PORT-ASSY-GR

Attachment Options

Snap Dock System
Full Coupler Set.

Wood Docks
*Adapter Hinge Kit, Stand Off Bracket,
or Pipe Mounting with Poly Brackets.*

Metal Docks
*Adapter Hinge Kit, Stand Off Bracket,
or Pipe Mounting with Poly Brackets.*



Snap Port Accessories

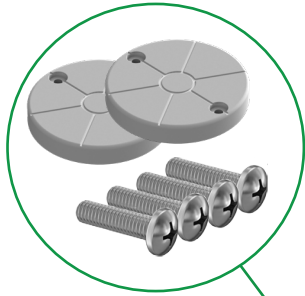

Port Cover Kit:

SKU PORT COVER-ASSY-GR

Bill of Material
 2 PORT COVER-GR
 4 SCREW-COV

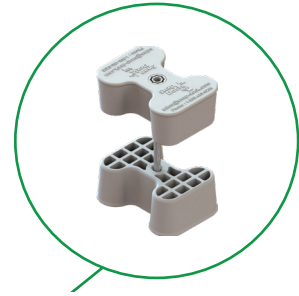

Port Coupler Set:

SKU CPLR-PORT-GR

Bill of Material
 2 CPLR-GR
 1 BOLT-S-GR
 1 NUT-GR
 1 DRIVETOOL

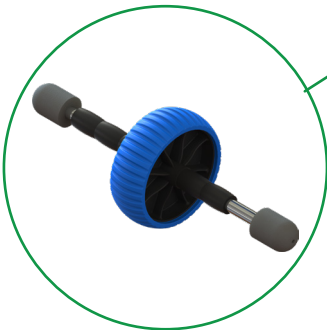
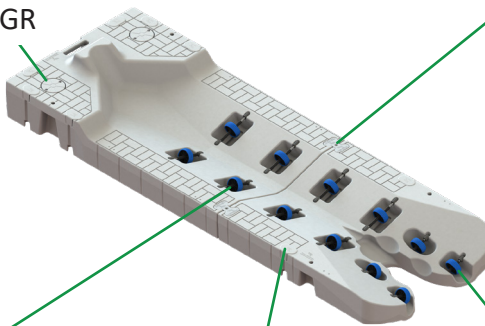

Roller Kit - Long Axle:

SKU ROLLER-L-ASSY

Bill of Material
 5 SPACER
 1 WHEEL
 2 PLUG
 1 SBAR-15



Pocket Filler:

SKU PFILL-GR

Bill of Material
 8 PFILL-GR

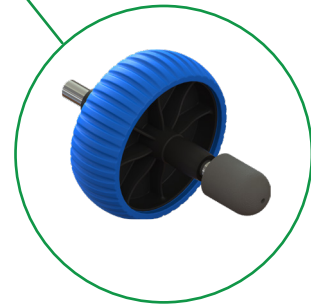

Roller Kit - Short Axle:

SKU ROLLER-S-ASSY

Bill of Material
 2 SPACER
 1 WHEEL
 1 PLUG
 1 SBAR-8



Modular Gangways & Ramps

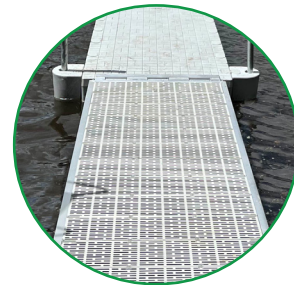
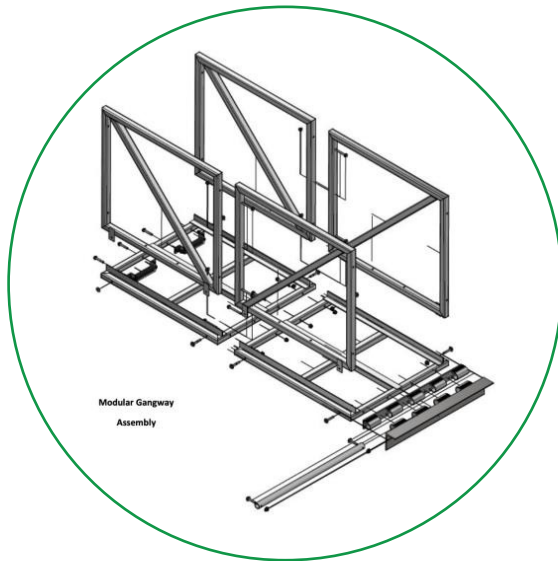

Product	SKU
Modular Gangways 3'x4'	GWAY-R-3X4
Modular Gangways 4'x4'	GWAY-R-4X4
Ramp 4'x8'	RAMP-4X8

Gangway Description:

The residential gangways are framed out with a “box” pattern utilizing 1” x 2” square tubing. In addition, railings are welded onto the frame. Modular gangways can be combined up to 28’ lengths.

Ramp Description:

The residential ramps are framed out with a “box” pattern utilizing 1” x 2” square tubing. Ramps exclude railings.

Note: All gangways & ramps come with composite decking.



Accessories

Product	SKU
3' Gangway Hinge (2-Pocket)	GHINGE-2P3
3' Gangway Hinge (2-Pocket)	GHINGE-3P3
4' Gangway Hinge (3-Pocket)	GHINGE-3P4
3' Roller Assembly	GROLLER-3
4' Roller Assembly	GROLLER-4
3' Abutment Hinge	HINGE-A3
4' Abutment Hinge	HINGE-A4
Fixed Ladder 5-Step	LADDER
Swivel Ladder 5-Rung	LADDER-S
Dog Step Ladder	DSTEP
Transition Plate 3'x4'	T-PLATE-3X4
Transition Plate 4'x4'	T-PLATE-4X4
Umbrella Sleeve	USTAND
Kayak Rack	K-RACK
Bench	BENCH

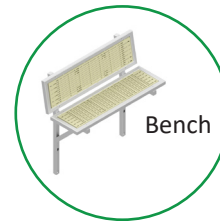
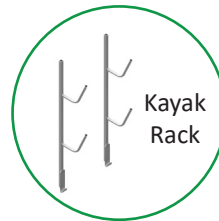
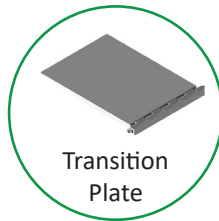
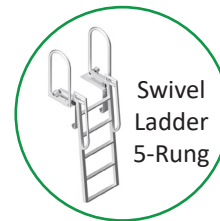
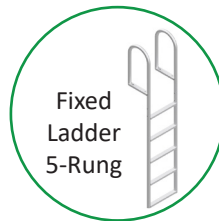
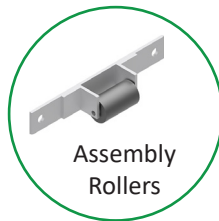

Coupler System

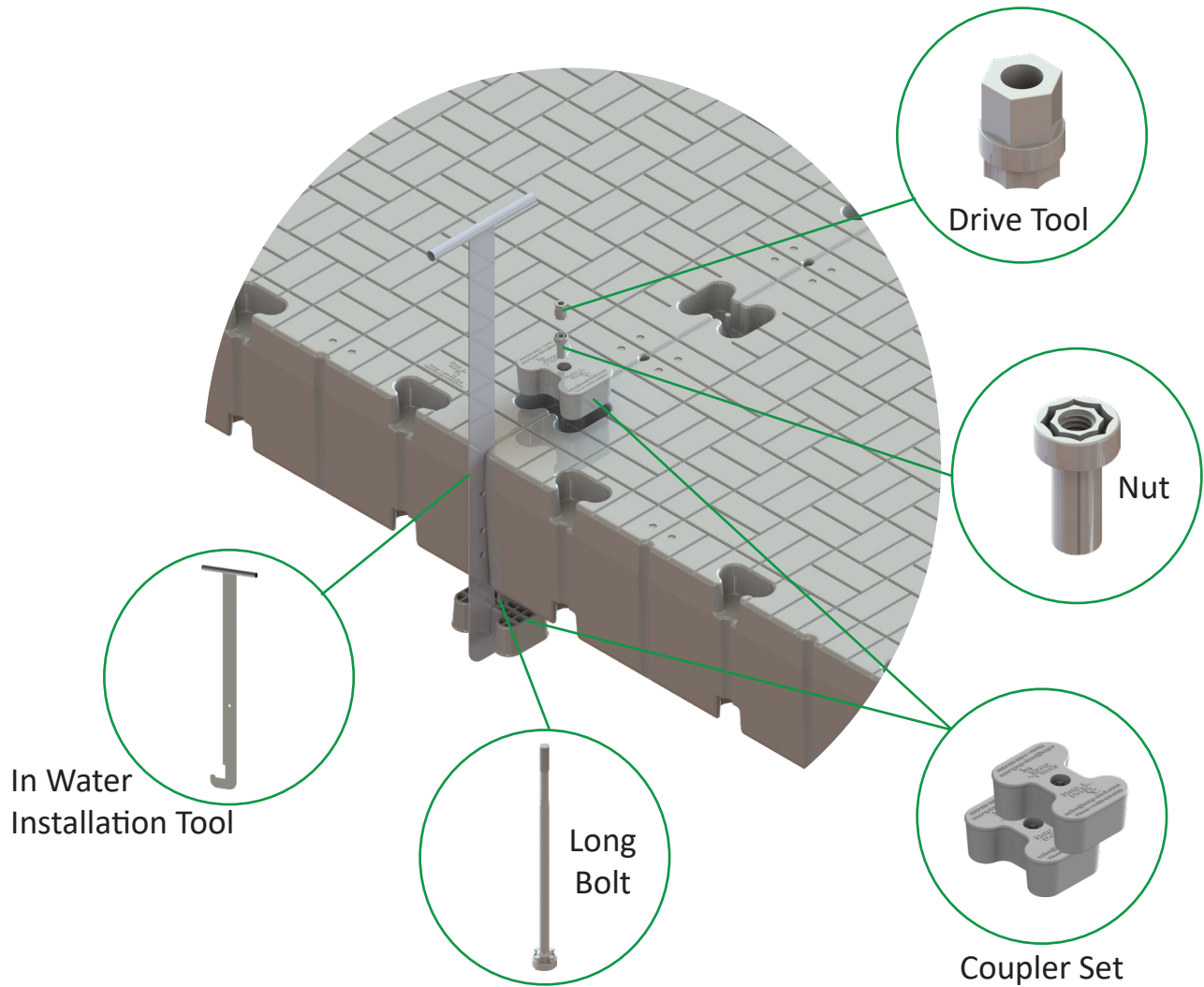

CPLR-SET-GR:

CPLR-GR	2
BOLT-L-GR	1
NUT-GR	1
DRIVETOOL	1

Individual SKUs:

SNAP INSTALL
CPLR-GR
BOLT-L-GR
NUT-GR
DRIVETOOL



Half Couplers

Hardware Connectors

Center-to-Center Distance
Between Pockets

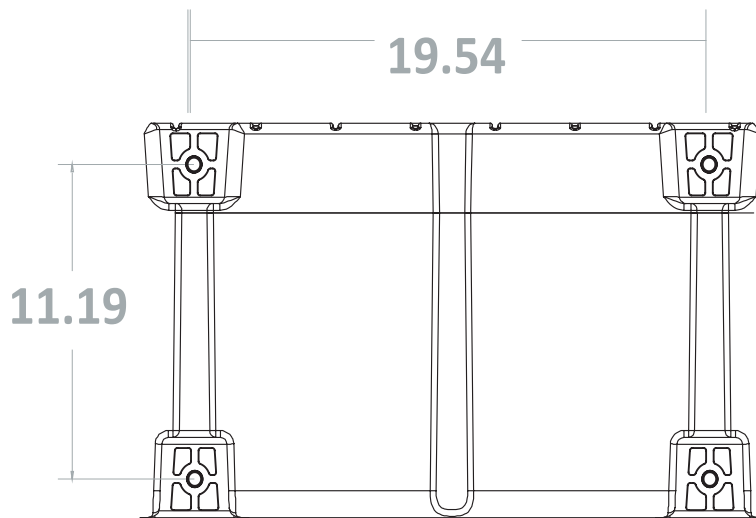

Male Half Coupler:

HALFCLPR-GR-ASSY	1
LOCKNUT-Z	1
WASHER	1

Note:
The molded bolt thread is 5/8" for the male half coupler.

DETAIL B

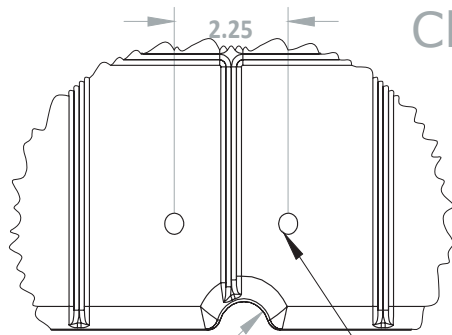

Cleat Mounting
Location

R0.50

18-8 STAINLESS THREADED INSERT
5/16"-18 X 0.375"



Female Half Coupler:

HALFCPLR-F-GR-ASSY	1
--------------------	---

Note:
5/8" hex bolt with stainless steel washer needed.

Hardware Excluded.



Anchoring: Hinge Kits

Galvanized Hinge Kit:

HINGE-KIT-GALV-U:	
Dock Assembly Hinge	1
Dock Assembly Hinge Plate	2
McMaster #92141A033	1
McMaster #92198A758	1
McMaster #91831A137	1

Extended Galvanized Hinge Kit:

HINGE-KIT-GALV-XL:	
Dock Assembly Hinge	1
Dock Assembly Hinge Plate	2
McMaster #92141A033	1
McMaster #92198A758	1
McMaster #91831A137	1

Stainless Steel Hinge Kit:

HINGE-KIT-GALV-SS-U:	
Dock Assembly Hinge	1
Dock Assembly Hinge Plate	2
McMaster #92141A033	1
McMaster #92198A758	1
McMaster #91831A137	1

Purchasing of individual mcmaster parts visit the [McMaster Website](https://www.mcmaster.com).

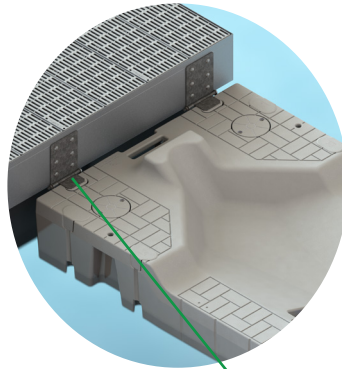

Galvanized & Stainless Steel Hinge Kits

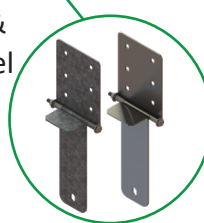

Extended Galvanized Hinge Kits

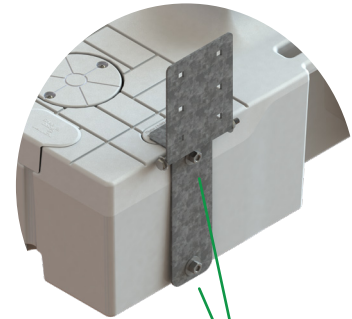
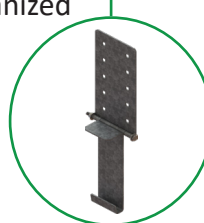

Male Half Coupler



Female Half Coupler

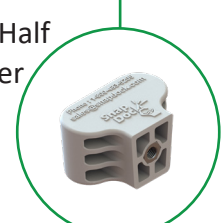

Male Half Coupler:

HALFCLPR-GR-ASSY	1
LOCKNUT-Z	1
WASHER	1

Note:
The molded bolt thread is 5/8" for the male half coupler.

Female Half Coupler:

HALFCLPR-F-GR-ASSY	1
--------------------	---

Note:
5/8" hex bolt with stainless steel washer needed.

Hardware Excluded.



Anchoring: Pipe Bracket



Standard Duty Pipe Bracket

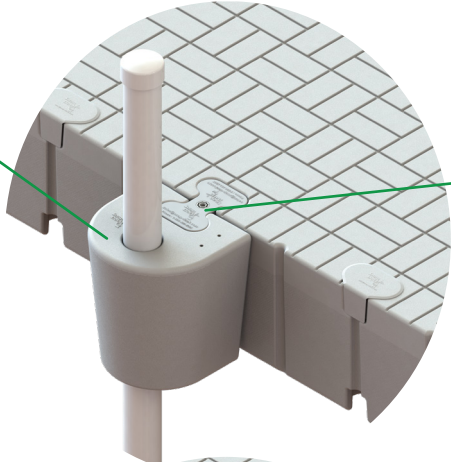

Coupler Set



Heavy Duty Pipe Bracket

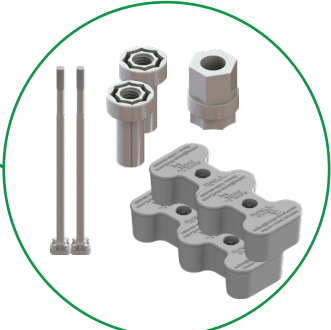
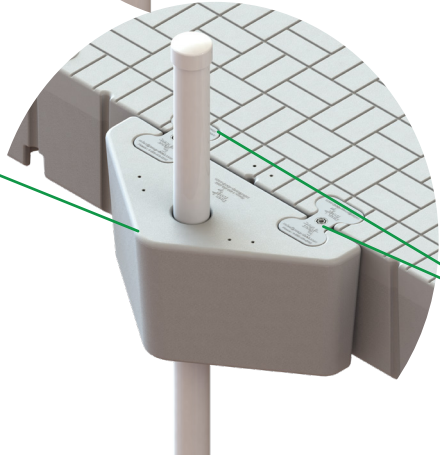

(2) Coupler Sets

Maximum Pipe Outside Diameter 3.5 Inches (3 Inch Nominal)

Standard Duty Pipe Bracket:

STD-BRKT-GR-ASSY	1
CPLR-SET-GR	1

Heavy Duty Pipe Bracket:

HD-BRKT-GR-ASSY	1
CPLR-SET-GR	2



Anchoring: Piling Bracket

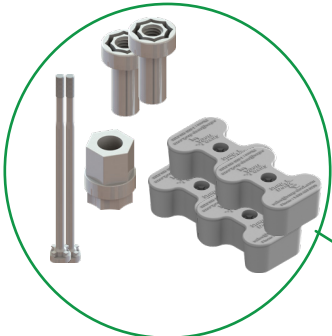

(2) Coupler Sets



(4) Pocket Fillers

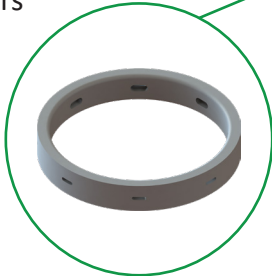

(1) Wear Ring &
Hardware

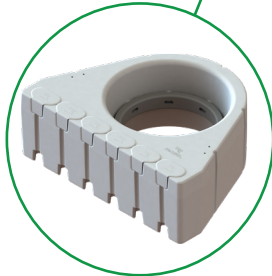

(1) Piling Bracket

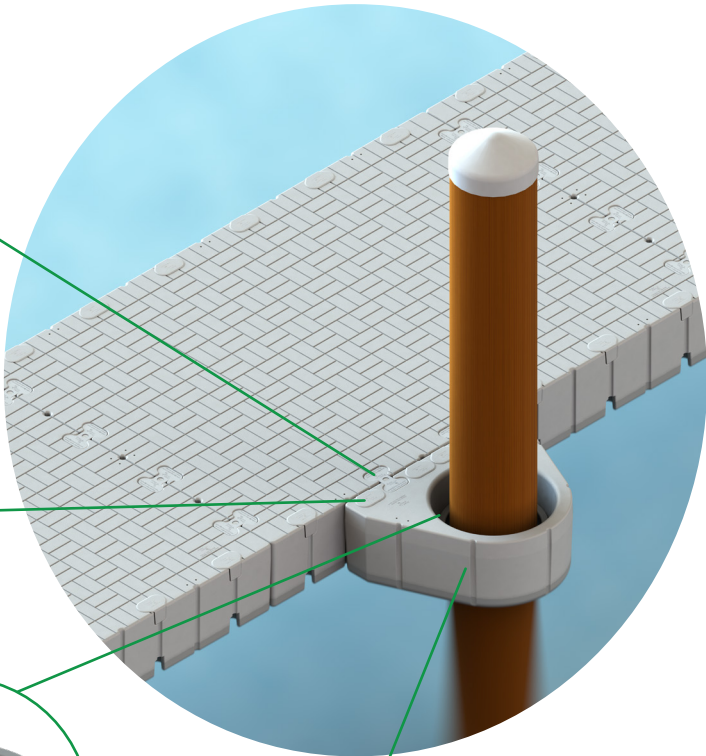

Piling Bracket:

PIL-BRKT-ASSY-GR	1
RING20X3	1
CPLR-SET-GR	2
PFILL-GR	4

Maximum Piling Diameter 16 Inches
The design incorporates a replaceable wear ring and six pockets to adjust the bracket in 6.5" increments.



Anchoring: Stand Off Brackets

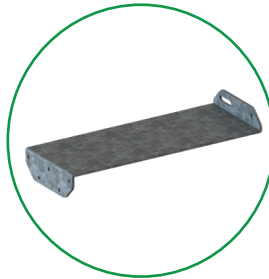

- or -

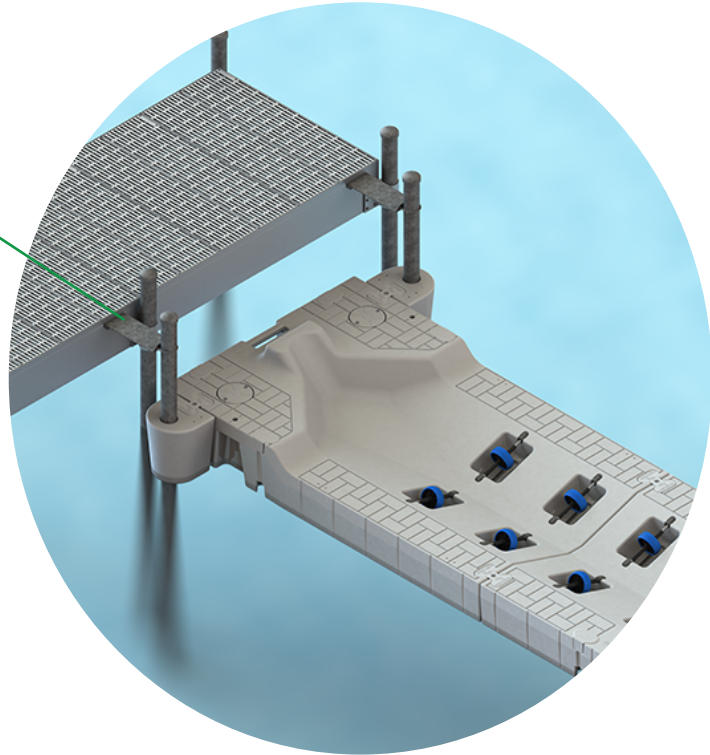

Stand Off Bracket:

SO BRKT 1

Fits up to 2 inch nominal pipe.
Actual Dimension is 2.5 inch OD.

"Z" Pipe Stand Off Bracket:

SO Z BRKT 1

* *5/16" Inch "U" Bolt* 1

* *Lock Nut* 2

Screws up to 1/4 inch can be
use to mount the "Z" Bracket.

Installation hardware is the responsibility of the buyer.



Anchoring: Deadweight Brackets

Male Half Coupler

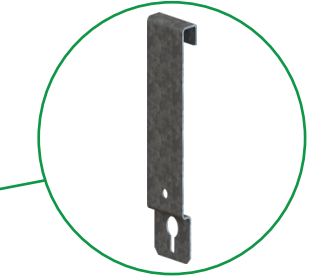
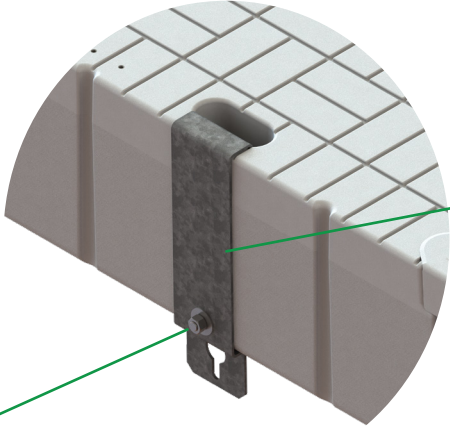
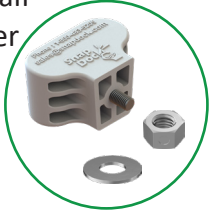

Standard Duty Galvanized Deadweight Bracket

-or-

Female Half Coupler

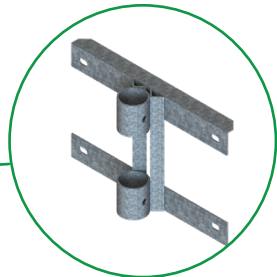
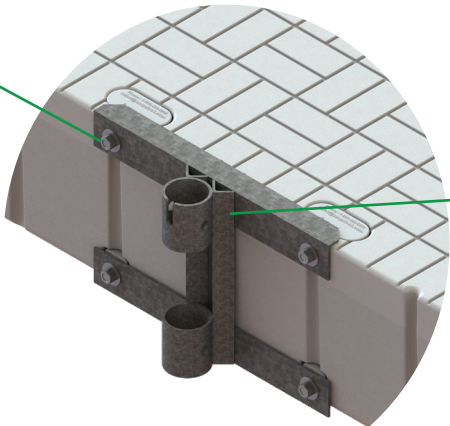

Heavy Duty Galvanized Deadweight Bracket

Standard Duty Galvanized Deadweight Bracket:

ANCR 1

Half Couplers Sold Separately

Heavy Duty Galvanized Deadweight Bracket:

ANCR-PIPE 1

Half Couplers Sold Separately



Anchoring: Stiff Arm Assembly

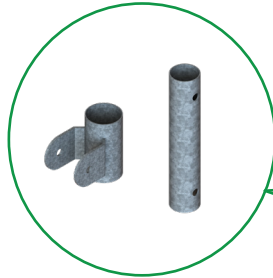

Stiff Arm Adapter

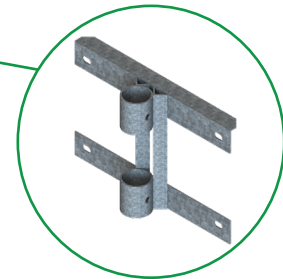
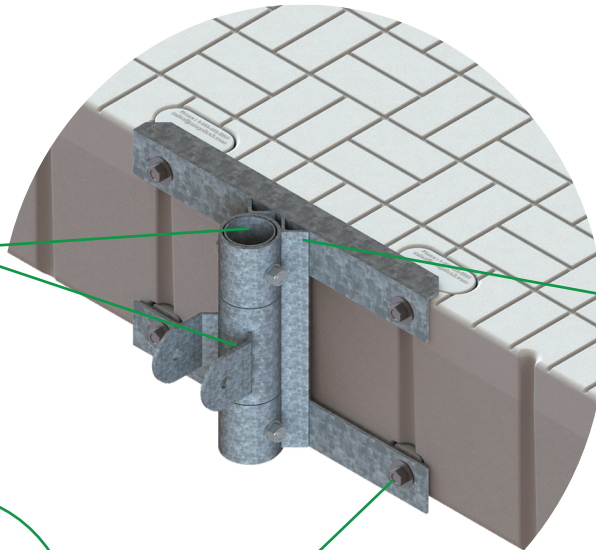

Heavy Duty Galvanized
Deadweight Bracket



Male Half Coupler

-or-

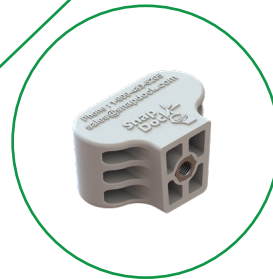

Female Half Coupler

Stiff Arm Assembly:

ANCR-PIPE	1
STIF-ADPT	1

Half Couplers Sold Separately

Stiff Arm Adapter:

STIF-ADPT	1
-----------	---

*Sold Separately:

- LOCKNUT-Z
- WASHER
- BOLT (McMaster # 92186A812)



Snap Dock Builder Tutorial

The Snap Dock Builder allows customers to configure their own dock layout which can then be shared with a dealer.

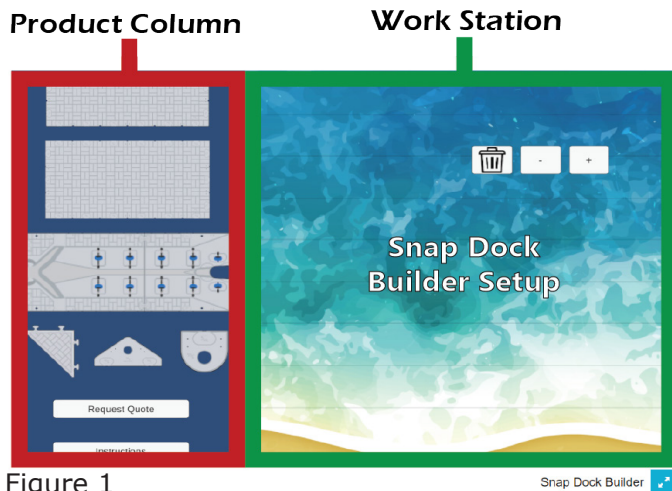

Figure 1

Figure 1 illustrates the initial screen an end user or dealer sees when clicking on the *Snap Dock Builder* Tab on our website.

The *Product Column* outlined in **RED** identifies Snap Dock Products that make up a draft of a dock layout.

The *Work Station* is outlined in **GREEN**, which identifies the area in which items will appear to construct a draft layout.

Figure 2 illustrates A 60" dock section that is selected to start a dock layout.

To choose a product, hover the mouse pointer over the desired item, then *single-click* to populate it into the workstation.

Note: Keep in mind that the number of times a product is selected will produce the same number of items into the workstation. If unwanted items populate, drag the item to the trash can to dispose of an object.

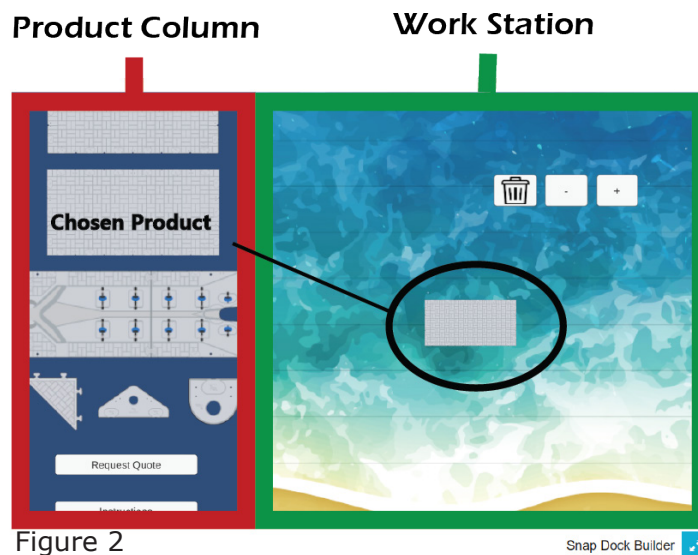

Figure 2



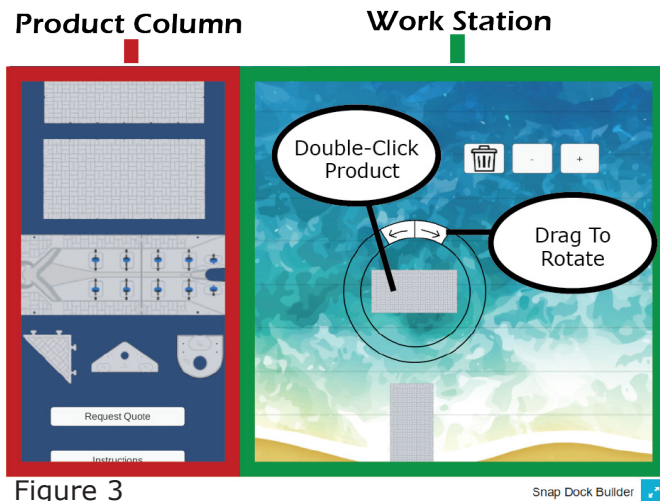

Figure 3

Figure 3 illustrates how to rotate a 60" component once it is into the workstation.

To rotate an object, the user needs to double-click directly on the product. The circular rotational tool will appear as two circles with opposite directional arrows. Use the cursor to click and drag the item in a circular motion for the preferred angle.

Figure 4 illustrates how a drafted layout will be presented using *Snap Dock Builder* application tool.

For end users, underneath the *Product Column* there for is a *Request Quote* button that will send the complete drafted layout to the sales team to will be sent to one of *Snap Dock's* dealers or distributors for quote.

For Dealers, create a screenshot of the Snap Dock Builder after a completed draft is done. This will create a image to share with the customer.

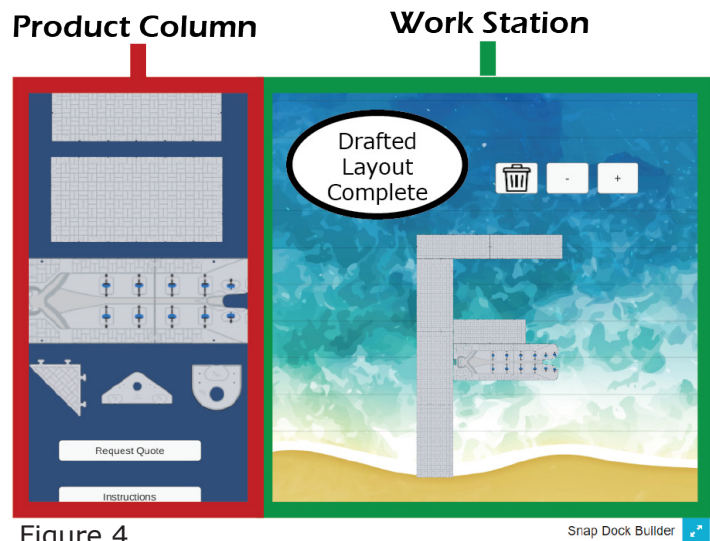
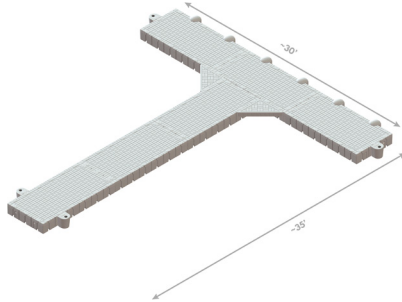

Figure 4

Residential Layouts



" T " Floating Dock

SNAP120X60-GR-2020	4
BUMPER-GR-ASSY	6
CORNER-GR-ASSY	4
STD-BRKT-GR-ASSY	4
CPLR-SET-GR	15

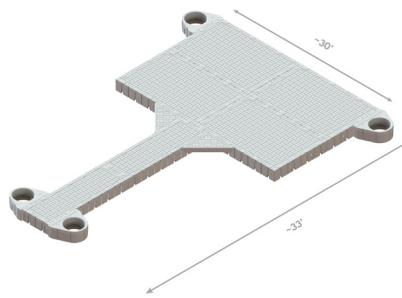

Platform Floating Dock

SNAP120X80-GR	4
SNAP120X40-GR	2
CORNER-GR-ASSY	2
PIL-BRKT-GR-ASSY	4
CPLR-SET-GR	28

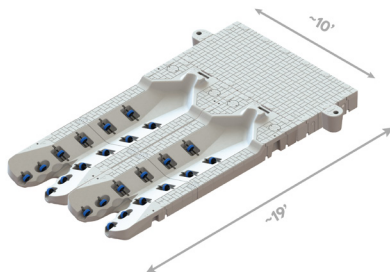

Multi Port & 60" Dock Configuration

SNAP120X60-GR-2020	1
SNAP PORT-ASSY-GR	2
STD-BRKT-GR-ASSY	2
CPLR-SET-GR	6

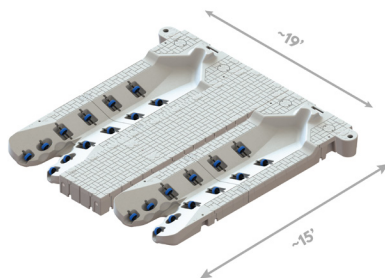

Multi Port & 40" Dock Configuration

SNAP120X40-GR	1
SNAP60X40-GR	1
SNAP PORT-ASSY-GR	2
CPLR-SET-GR	6



Commercial Layouts

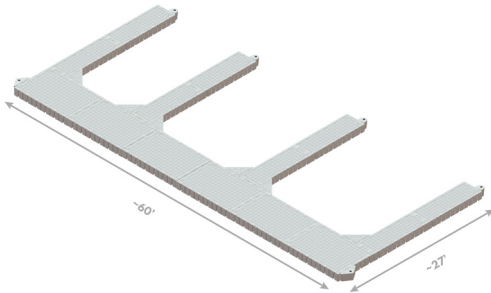

" U " Shape Multi-Slip Dock

SNAP120X80-GR	6
SNAP120X40-GR	8
CORNER-GR-ASSY	6
STD-BRKT-GR-ASSY	4
HD-BRKT-GR-ASSY	2
CPLR-SET-GR	36

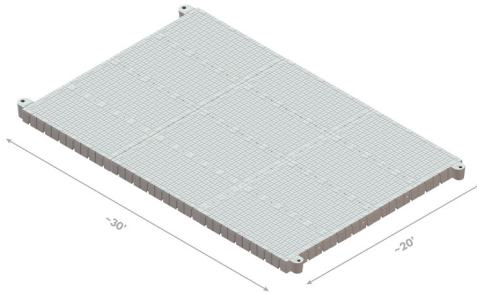

Platform Floating Dock

SNAP120X60-GR-2020	12
STD-BRKT-GR-ASSY	4
CPLR-SET-GR	78

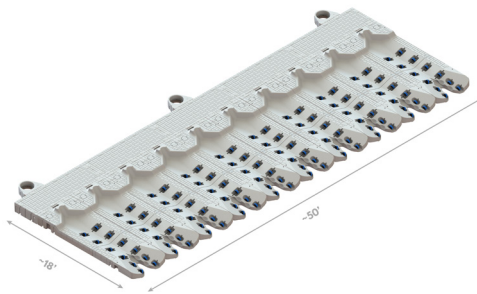

Multi-Slip Snap Port Dock

SNAP120X40-GR	5
SNAP PORT-ASSY-GR	10
PIL-BRKT-GR-ASSY	3
CPLR-SET-GR	38

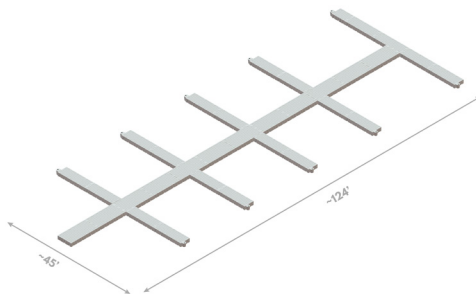

Multi-Slip Marina

SNAP120X60-GR-2020	12
SNAP120X40-GR	20
SNAP60X40-GR	1
STD-BRKT-GR-ASSY	10
CPLR-SET-GR	76



Industrial Applications

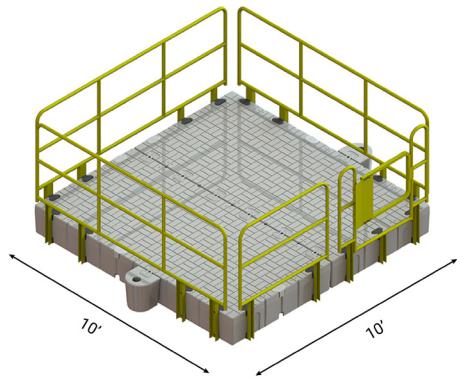

Work Platform

SNAP120X60-GR-2020	2
STD-BRKT-GR-ASSY	2
CPLR-SET-GR	6
HALFCPLR-GR-ASSY	34
HR-111-YELLOW	3
HR-52-YELLOW	1
HR-52-G-YELLOW	1

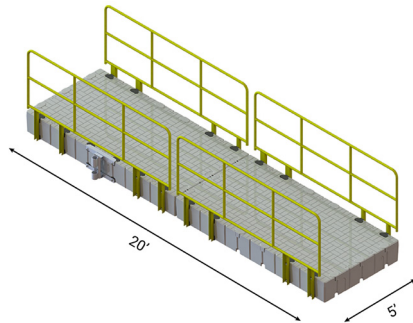

Walkway

SNAP120X60-GR-2020	2
ANCR-PIPE	1
CPLR-SET-GR	3
HALFCPLR-GR-ASSY	36
HR-111-YELLOW	4

Plastic Products

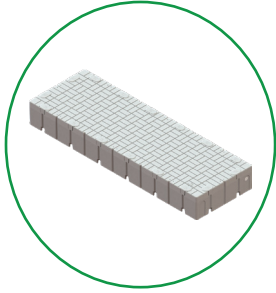

40" Dock Section

SKU: SNAP120x40-GR

Dimension: 117" x 39"

Description:

(1) 40" dock section (light gray), & (12) pocket fillers.

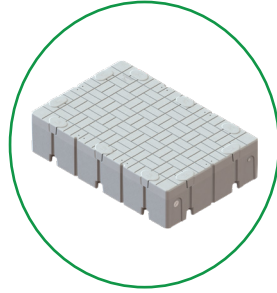

4060 Dock Section

SKU: SNAP60x40-GR

Dimension: 59" x 39"

Description:

(1) 6040 dock section (light gray), & (6) pocket fillers.

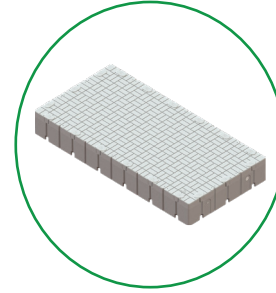

60" Dock Section

SKU: SNAP120x60-GR 2020

Dimension: 117" x 59"

Description:

(1) 60" dock section (light gray), & (12) pocket fillers.

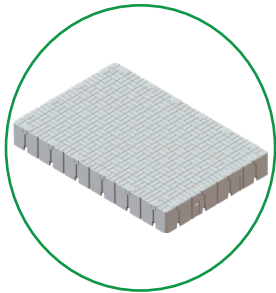

80" Dock Section

SKU: SNAP120X80-GR

Dimension: 117" x 79"

Description:

(1) 80" dock section (light gray), & (12) pocket fillers.

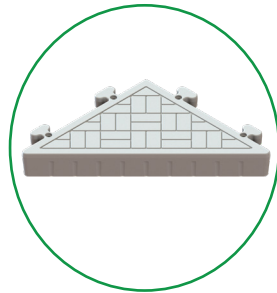

Corner Gusset

SKU: CORNER-GR-ASSY

Dimension: N/A

Description:

(1) corner gusset (light gray), & (1) corner gusset bolt kit.



Snap Port Assembly

SKU: SNAP PORT-ASSY-GR

Dimension: 168" x 59"

Description:

(1) snap port assembly (light gray). see page 14 for specifications.



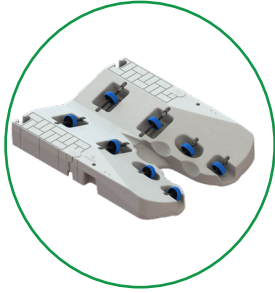

Port Entrance Assembly

SKU: PORT ENT-GR-ASSY

Dimension: 72" x 59"

Description

(1) port entrance (light gray), (4) long port roller set, (4) short port roller sets, & (2) pocket fillers.



Port Front Assembly

SKU: PORT FRONT-GR-ASSY

Dimension: 96" x 59"

Description

(1) port front (light gray), (4) long port roller set, (1) port cover kit, & (6) pocket fillers.

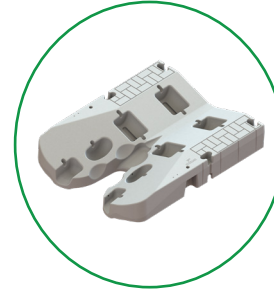

Port Entrance

SKU: PORT ENT-GR

Dimension: 72" x 59"

Description

(1) port entrance (light gray).

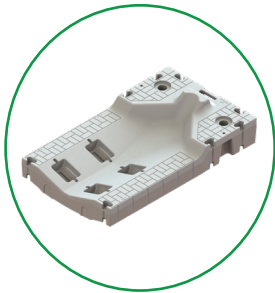

Port Front

SKU: PORT FRONT-GR

Dimension: 96" x 59"

Description

(1) port front (light gray).



Connector Products



Coupler

SKU: CPLR-GR

Dimension: N/A

Description
(1) coupler (light gray).

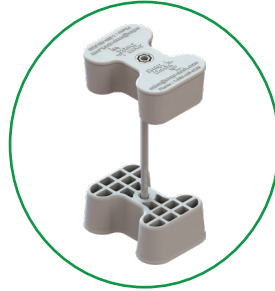

Full Coupler Set

SKU: CPLR-SET-GR

Dimension: N/A

Description
(2) couplers (light gray), (1) long bolt, (1) nut, & (1) drive tool.



Female Half Coupler

SKU: HALFCPLR-F-GR-ASSY

Dimension: N/A

Description
(1) female half coupler (light gray).



Male Half Coupler

SKU: HALFCPLR-GR-ASSY

Dimension: N/A

Description
(1) male half coupler (light gray), (1) washer, & (1) zinc locknut.

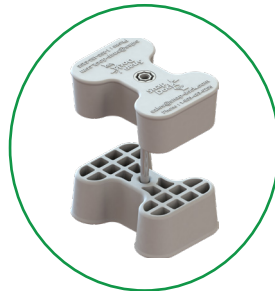

Port Coupler Set

SKU: CPLR-PORT-GR

Dimension: N/A

Description
(2) couplers (light gray), (1) short bolt, (1) nut, & (1) drive tool.

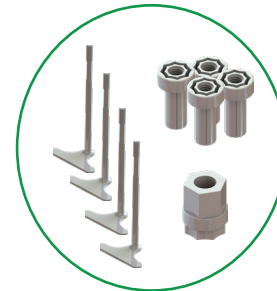

Corner Gusset Bolt Kit

SKU: CBOLT-KIT-GR

Dimension: N/A

Description
(4) corner gusset bolts, (4) nuts, and (1) drive tool.



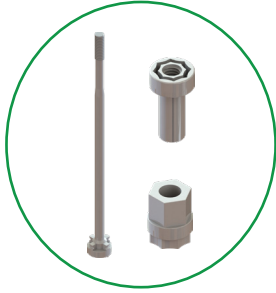

Coupler Bolt Kit

SKU: BOLT-KIT-GR

Dimension: N/A

Description

(1) long bolt, (1) nut, & (1) drive tool.



Port Coupler Bolt Kit

SKU: BOLT-S-KIT-GR

Dimension: N/A

Description

(2) port coupler bolts, (2) nuts, & (1) drive tool.



Corner Gusset Bolt

SKU: CBOLT-GR

Dimension: N/A

Description

(1) corner gusset bolt.



Coupler Long Bolt

SKU: BOLT-L-GR

Dimension: N/A

Description

(1) long bolt.



Nut

SKU: NUT-GR

Dimension: N/A

Description

(1) nut.

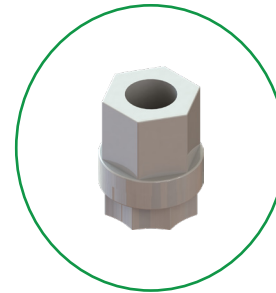

Drive Tool

SKU: DRIVETOOL

Dimension: N/A

Description

(1) drive tool.





Port Coupler Short Bolt

SKU: BOLT-S-GR

Dimension: N/A

Description
(1) port coupler short bolt.



Anchoring

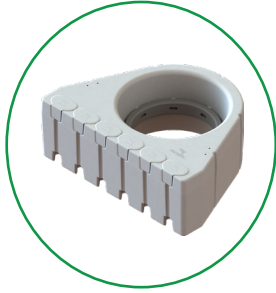

Piling Bracket

SKU: PIL-BRKT-GR-ASSY

Dimension: N/A

Description

(1) piling bracket (light gray), (1) replaceable wear ring, (2) coupler sets, & (4) pocket fillers.



Heavy Duty Pipe Bracket

SKU: HD-BRKT-GR-ASSY

Dimension: N/A

Description

Includes: (1) heavy duty pipe bracket (light gray), & (2) coupler set.



Standard Duty Pipe Bracket

SKU: STD-BRKT-GR-ASSY

Dimension: N/A

Description

Includes: (1) standard duty pipe bracket (light gray), & (1) coupler set.



" Z " Pipe Stand Off Bracket

SKU: SO Z BRKT

Dimension: N/A

Description

(1) galvanized "Z" stand off bracket.



Extended Galvanized Hinge Kit

SKU: HINGE-KIT-GALV-XL

Dimension: N/A

Description

(2) extended galvanized hinge kit complete set of 2. order with (2) male half couplers.

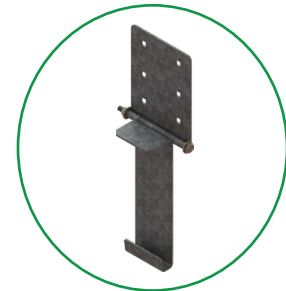

Galvanized Hinge Kit

SKU: HINGE-KIT-GALV

Dimension: N/A

Description

(1) galvanized hinge kit complete set of 2. order with (2) male half couplers.



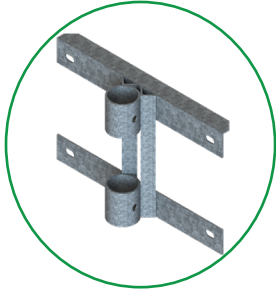

Heavy Duty Galvanized Deadweight Bracket

SKU: ANCR-PIPE

Dimension: N/A

Description

(1) galvanized heavy duty deadweight & pipe bracket. **order with (4) male half couplers.**

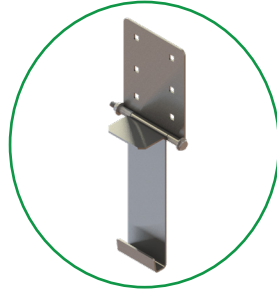

Stainless Steel Hinge Kit

SKU: HINGE-KIT-SS

Dimension: N/A

Description

(1) stainless steel hinge kit complete set of 2. **order with (2) male half couplers.**



Stand Off Bracket

SKU: SO BRKT

Dimension: N/A

Description

(1) galvanized stand off bracket fitting 2" nominal OD or 2.5" actual pipe OD.

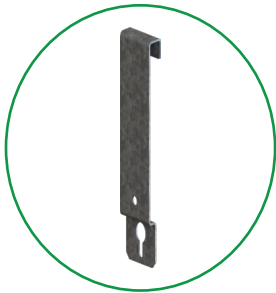

Standard Duty Galvanized Deadweight Bracket

SKU: ANCR

Dimension: N/A

Description

(1) galvanized standard duty deadweight anchor bracket. **order with (1) male half coupler.**

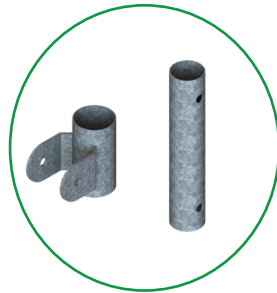

Stiff Arm Adapter

SKU: STIF-ADPT

Dimension: N/A

Description

(1) stiff arm adapter.

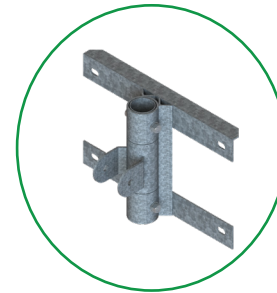

Stiff Arm Assembly

SKU: STIF-ASSY

Dimension: N/A

Description

(1) galvanized heavy duty deadweight & pipe bracket & (1) stiff arm adapter. **order with (4) male half couplers.**



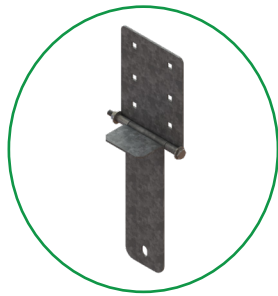

Universal Galvanized
Hinge Kit

SKU: HINGE-KIT-GALV-U

Dimension: N/A

Description
(1) galvanized hinge kit set of 2.
order with (4) male half couplers.

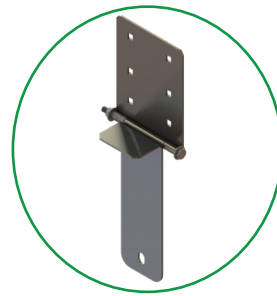

Universal Stainless Steel
Hinge Kit

SKU: HINGE-KIT-SS-U

Dimension: N/A

Description
(1) stainless steel hinge kit
complete set of 2. order with (4)
male half couplers.

Gangways & Ramps

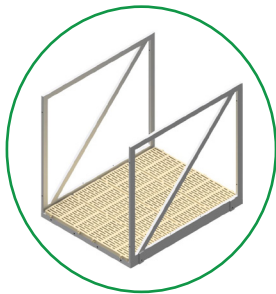

3' x 4' Modular Gangway

SKU: GWAY-R-3x4

Dimension: 3' X 4'

Description
(1) 3' x 4' modular gangway & composite decking unless aluminum is requested.

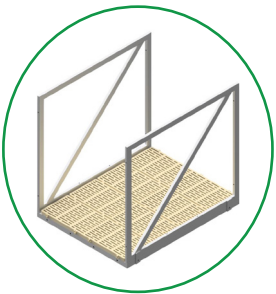

4' X 4' Modular Gangway

SKU: GWAY-R-4x4

Dimension: 4' x 4'

Description
(1) 4' x 4' modular gangway & composite decking unless aluminum is requested.

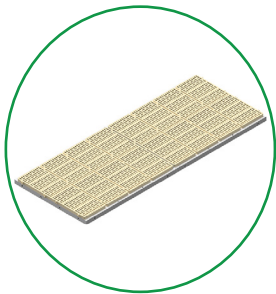

4' x 8' Ramp

SKU: RAMP-4x8

Dimension: 4' x 8'

Description
(1) 4' x 8' ramp & composite decking unless aluminum is requested.



Accessories



3' Abutment Hinge

SKU: HINGE-A3

Dimension: N/A

Description
(1) 3' abutment hinge.



4' Abutment Hinge

SKU: HINGE-A4

Dimension: N/A

Description
(1) 4' abutment hinge.

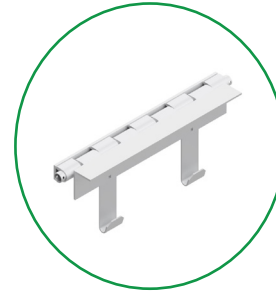

3' Gangway Hinge (2-Pocket)

SKU: GHINGE-2P3

Dimension: N/A

Description
(1) 2-pocket bolt-on dock hinge for 3' gangway or ramp.

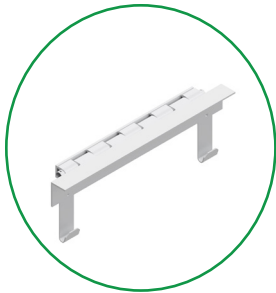

3' Gangway Hinge (3-Pocket)

SKU: GHINGE-3P3

Dimension: N/A

Description
(1) 3-pocket bolt-on dock hinge for 3' gangway or ramp.



4' Gangway Hinge (3-Pocket)

SKU: GHINGE-3P4

Dimension: N/A

Description
(1) 3-pocket bolt-on dock hinge for a 4' gangway or ramp.

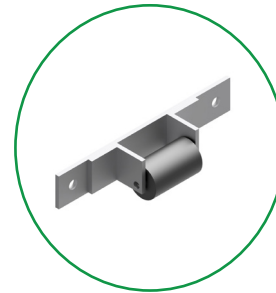

3' Roller Assembly

SKU: GROLLER-3

Dimension: N/A

Description
(1) 3' roller assembly for a gangway or ramp.



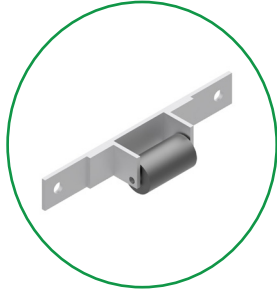

4' Roller Assembly

SKU: GROLLER-4

Dimension: N/A

Description

(1) 4' roller assembly for a gangway or ramp

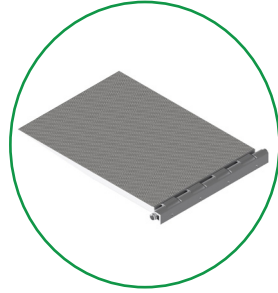

3' x 4' Transition Plate

SKU: T-PLATE-3x4

Dimension N/A

Description

(1) 3' x 4' transition plate.

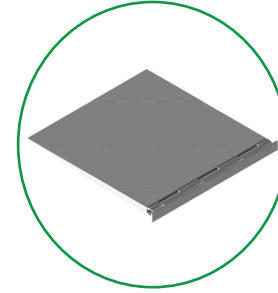

4' x 4' Transition Plate

SKU: T-PLATE-4x4

Dimension: N/A

Description

(1) 4' x 4' transition plate.

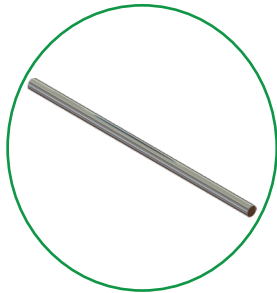

Long Stainless Steel Axis

SKU: SBAR-15

Dimension: N/A

Description

(1) long stainless steel axis.

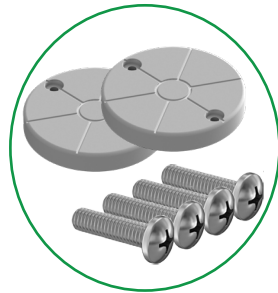

Port Cover Kit

SKU: PORT COVER-ASSY-GR

Dimensions: N/A

Description

(2) port covers (light gray), & (4) 5/16"-18 stainless 1-1/4" screws.

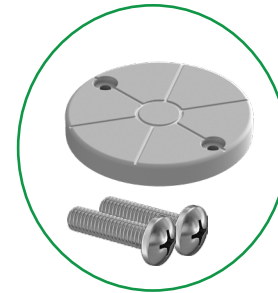

Port Cover

SKU: PORT COVER-GR

Dimensions: N/A

Description

(1) port cover (light gray), & (2) 5/16"-18 stainless 1-1/4" screws.





Port Roller Long Set

SKU: ROLLER-L

Dimension: N/A

Description

(1) port wheel, (5) spacers, (2) plugs, & (1) long stainless steel axis.



Port Roller Plug

SKU: PLUG

Dimension: N/A

Description

(1) plug.



Port Roller Short Set

SKU: ROLLER-S

Dimension: N/A

Description

(1) port wheel, (2) spacers, (1) plug, & (1) short stainless steel axis.



Port Roller Wheel

SKU: WHEEL

Dimension: N/A

Description

(1) port wheel.



Port Spacer

SKU: SPACER

Dimension: N/A

Description

(1) spacer.

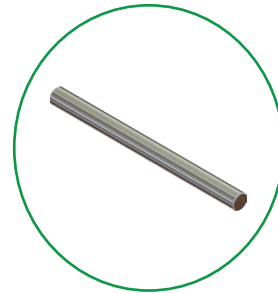

Short Stainless Steel Axis

SKU: SBAR-8

Dimension: N/A

Description

(1) short stainless steel axis.





Bench

SKU: BENCH

Dimension: N/A

Description
(1) bench.



Dog Step Ladder

SKU: DSTEP

Dimension: N/A

Description
(1) dog step up ladder.

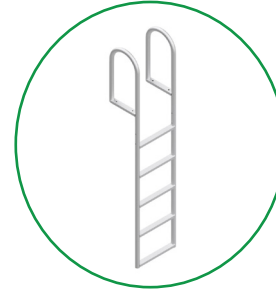

Fixed Ladder 5-Step

SKU: LADDER

Dimension: N/A

Description
(1) fixed five step ladder.

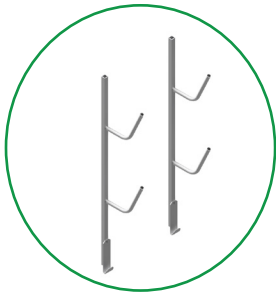

Kayak Rack

SKU: K-RACK

Dimension: N/A

Description
(1) kayak rack.

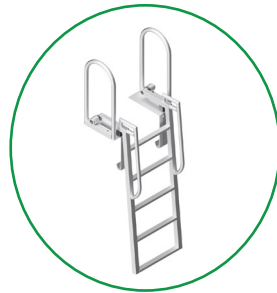

Swivel Ladder 5-Rung

SKU: LADDER-S

Dimension: N/A

Description
(1) swivel ladder five rung.

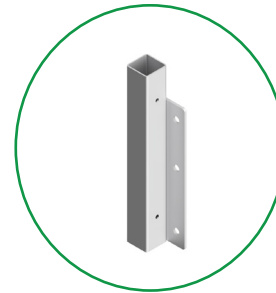

Umbrella Stand Sleeve

SKU: USTAND

Dimension: N/A

Description
(1) 4' x 4' transition plate.





8" Nylon Cleat

SKU: CLEAT-8-ASSY

Dimension: N/A

Description

(1) 8" nylon cleat, & (2) 5/16" cleat screws.



Breather Vent

SKU: VENT-GR

Dimension: N/A

Description

(1) m12x1.5 vent.



Bumper

SKU: BUMPER-GR-ASSY

Dimension: N/A

Description

(1) bumper (light gray), (1) female half coupler, (1) washer, & (1) 3" stainless steel bolt.



White Coupler Light

SKU: CPLR LITE WH

Dimension: N/A

Description

(2) lakelite solar light.

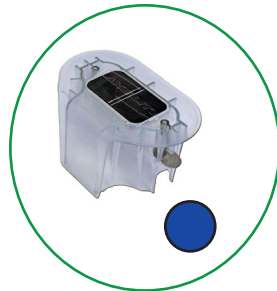

Blue Coupler Light

SKU: CPLR LITE BL

Dimension: N/A

Description

(2) lakelite solar light.

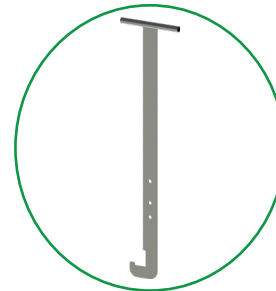

In Water Installation Tool

SKU: SNAP INSTALL

Dimensions: N/A

Description

(1) in water installation tool.





Pocket Filler

SKU: PFILL-GR

Dimension: N/A

Description
(1) pocket filler (light gray).



Wear Ring

SKU: RING20X3

Dimension: N/A

Description
(1) replacable wear ring & 5/16" hardware set.

Hardware Products

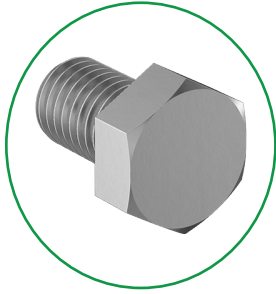

1" Stainless Steel Bolt

SKU: BOLT-1

Dimension: N/A

Description

(1) 5/8"-11 stainless steel bolt x 1".

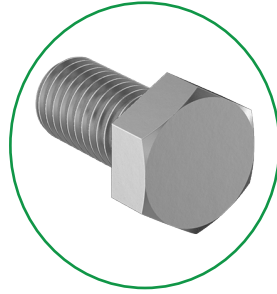

1.25" Stainless Steel Bolt

SKU: BOLT-1.25

Dimension: N/A

Description

(1) 5/8"-11 stainless steel bolt x 1-1/4".

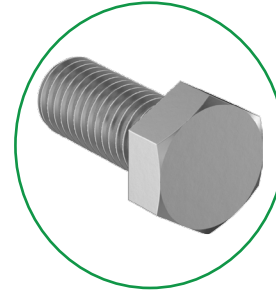

1.50" Stainless Steel Bolt

SKU: BOLT-1.5

Dimension: N/A

Description

(1) 5/8"-11 stainless steel bolt x 1-1/2".

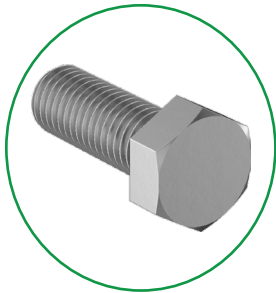

1.75" Stainless Steel Bolt

SKU: BOLT-1.75

Dimension: N/A

Description

(1) 5/8"-11 stainless steel bolt x 1-3/4".

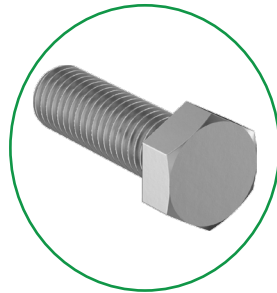

2" Stainless Steel Bolt

SKU: BOLT-2

Dimension: N/A

Description

(1) 5/8"-11 stainless steel bolt x 2".

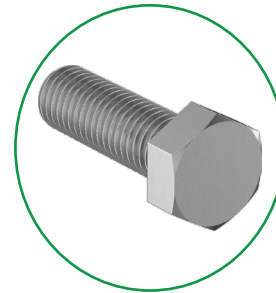

3" Stainless Steel Bolt

SKU: BOLT-3

Dimension: N/A

Description

(1) 5/8"-11 stainless steel bolt x 3".





Cleat Screw

SKU: SCREW-CLT

Dimension: N/A

Description
(2) 5/16"-18 stainless 2"
cleat screws.

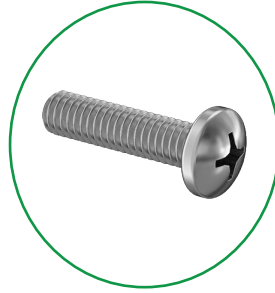

Port Cover Screw

SKU: SCREW-COV

Dimensions: N/A

Description
(2) 5/16"-18 stainless 1-1/4"
port cover screws.

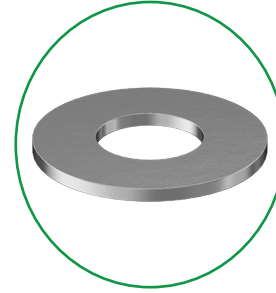

Stainless Steel Washer

SKU: WASHER

Dimension: N/A

Description
(1) 18-8 stainless steel washer for
5/8" screw size, 0.688" ID 1 1/2"
OD.



Stainless Steel Lock Washer

SKU: WASHERL

Dimension: N/A

Description
(1) 18-8 stainless steel lock washer
for 5/8" screw size, 0.688" ID
1-1/2" OD.

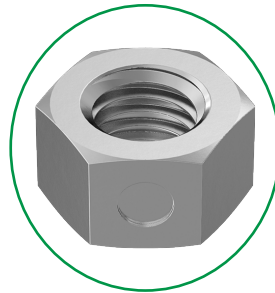

Zinc Locknut

SKU: LOCKNUT-Z

Dimension: N/A

Description
(1) 5/8"-11 thread size zinc
locknut.



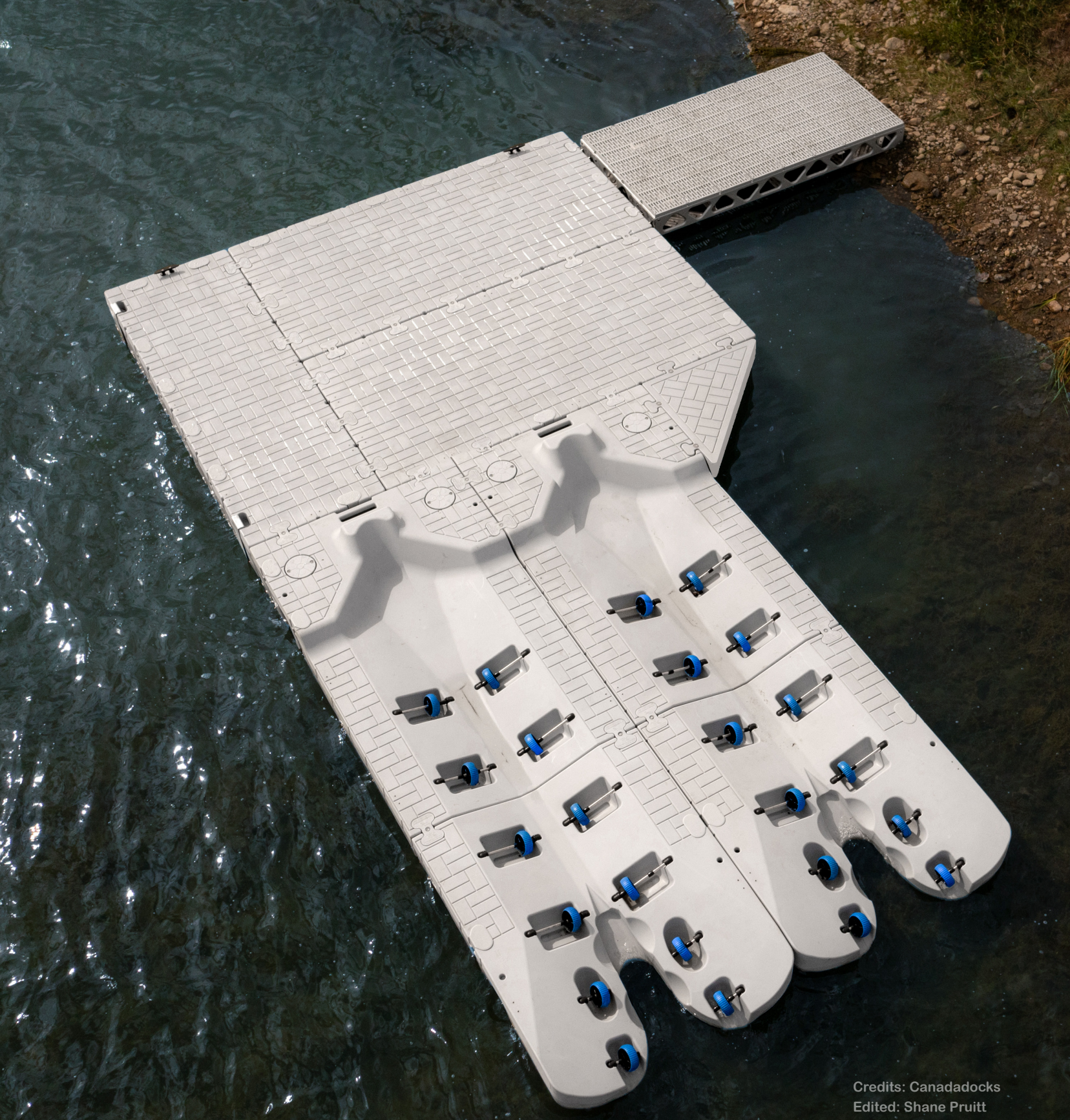

Credits: Canadadocks
Edited: Shane Pruitt



1-807-357-3730

info@docksbythebay.com

Thunder Bay, Ontario

www.docksbythebay.com